



KOBZARENKO



DUMP TRAILERS



www.kobzarenko.com.ua



TSP-10



TSP-14



TSP-16



TSP-20



TSP-30



TSP-40



Semi-trailer TSP-40

Tractor dumper trailers intended for transporting all kind of agricultural goods (grain, green mass, organic and mineral fertilizers, etc.).

Features of construction:

- solid welded conical body with stiffeners on trailers with one side of unloading and reinforced profile boards with stiffeners on trailers with three sides of unloading;
- reinforced frame on leaf spring suspension;
- mechanically or hydraulically opened back board with special gate valve for dozing of unloading;
- back board adopted for installing reloading auger for loading the seeders;
- priming and painting with polyurethane paint Lankwitzer (produced by Germany);
- braking system: pneumatic, hydraulic or mixed.

Equipment:

- running gear of trailer ADR (Italy), BPW (Germany);
- hydraulic cylinder Di Natale-Bertelli (Italy)
- towing eye Scharmüller (Austria);
- tires Mitas, BKT, Alliance;
- hydraulic drawbar support on semi-trailers.

Additional equipment:

- stripes for additional volume;
- awning system;
- lookout platform;
- auger for loading the seeders.

SUSPENSION TYPES



Tandem



Tridem



Hydraulic

TOWING CONNECTIONS, SCHARMÜLLER AUSTRIA

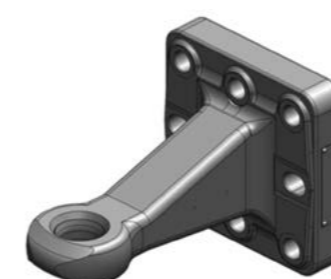

Ø40



Ø50

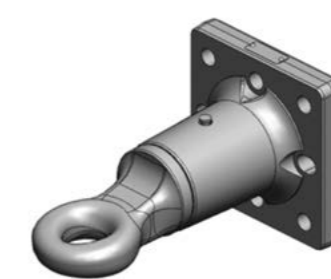

turning eye Ø50

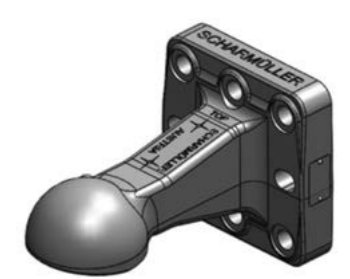

hemisphere Ø80



Semi-trailers	TSP-10	TSP-14	TSP-16	TSP-20	TSP-30	TSP-40
Sides of unloading	1	1	1	1	1	1
Empty weight, kg	2 400	3 400	4 300	5 950	6 840	10 000
Technically permissible total mass, kg	10 400	13 400	16 300	21 950	26 840	40 000
Axles, pcs.	2	2	2	2	2	3
Body: length, mm	4 450	5 140	5 140	5 600	6 500	8 000
width, mm	2190/2240	2175/2235	2230/2310	2230/2295	2 325	2 325
height, mm	1 115	975	1 540	1 540	1 475	1 640
Height stripes, mm	-	600	600	600	600	600
Volume, m ³	10,7	10,7	17,2	19,5	21	29
Volume with stripes, m ³	-	17,5	24	27,3	30	40
Standart wheels	11,5/80-15,3	425/70-18	425/70-18	550/60-22,5	560/60R22,5	560/60R22,5
Maximum wheels	400/60-15,5	500/50-22,5	560/45R22,5	650/50R22,5	710/50 R 26,5	710/50 R 26,5
Recommended tractor power (hp)	80	100-110	120	150-180	220-250	250-300

Semi-trailer TSP-20. Conical body - prevents hovering of green mass and manure in trailer

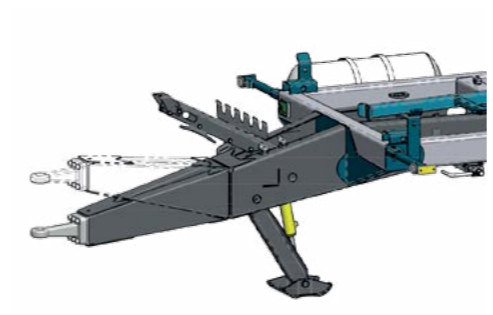

Swivelled drawbar



Hydraulic adjustable drawbar

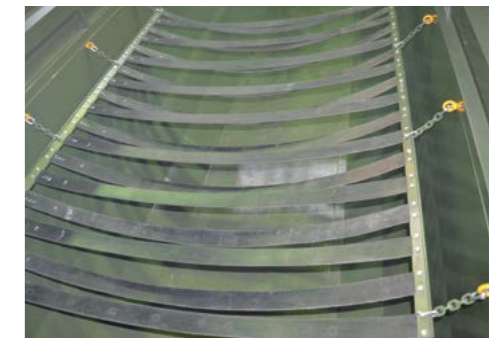

Hock absorber for falling potatoes of rubber belts.



Hydraulic drawbar support



Side opening board TSP-10

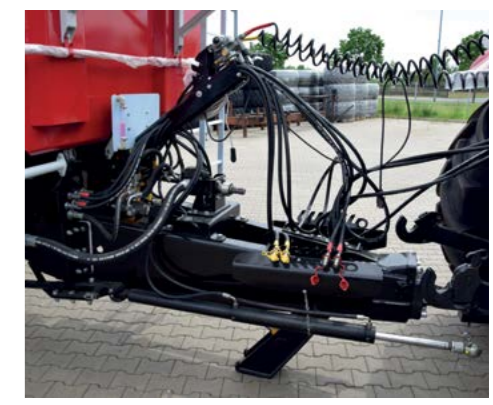

Hydraulic machine TSP-40



Hydraulic brake system

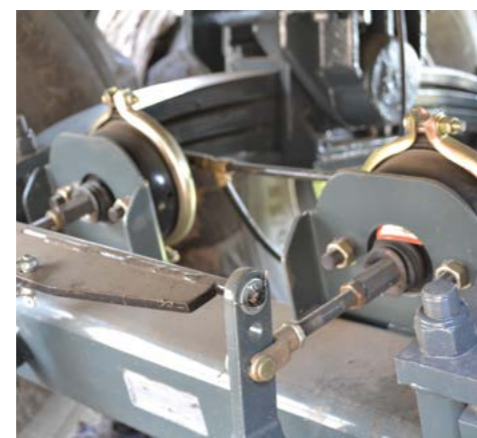

Air brake system

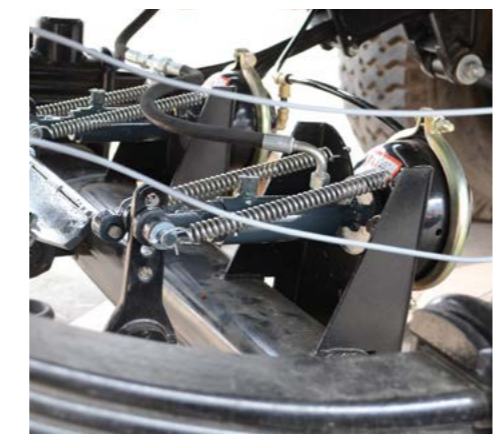

Combined braking system



First and last axles are positively steered



Hydraulic suspension



Auger on trailer with rear unloading



Semi-trailer TSP-16t



Semi-trailers	TSP-3t	TSP-6t	TSP-10t	TSP-16t
Sides of unloading	3	3	3	3
Empty weight, kg	800	1 600	2 300	4 600
Technically permissible total mass, kg	3 300	6 000	10 300	12 600
Axles, pcs.	1	1	2	2
Body: length, mm	2 890	4 015	4 530	4 930
width, mm	1 740	2 105	2 200	2 270
height, mm	500	500	500	600
The height of the 2nd tier of the sides, mm	500	500	500	800
Volume with 1 tiers of sides, m ³	2,6	4,2	-	-
Volume with 2 tiers stripes, m ³	5,2	8,4	10,0	16
Standart wheels	10.0/75 -15,3	11,5/80-15,3	11,5/80-15,5	425/70-18
Maximum wheels		355/65-16	400/60-15,5	500/50-22,5
Recommended tractor power (hp)	34	60	80	120-150



Wheel chock



Toolbox



Mechanical drawbar support TSP-3



Mechanical drawbar support with TSP-6t wheel



Hydraulic drawbar support TSP-10t, TSP-16t



Dumper trailers with three sides of unloading easily transforming in to usual platform, what is makes them multifunctional.



Side unloading



Side unloading



Lock for opening the board



Upper bracket



Lower bracket with attachment

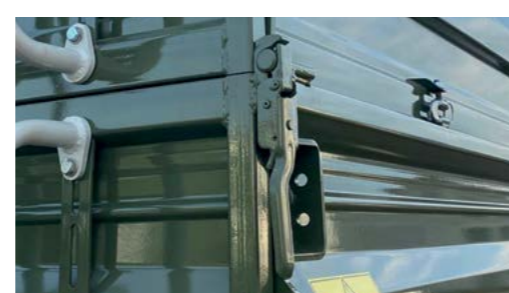

Side lock



TSP-3t



TSP-6t



TSP-10t



Back unloading



Back unloading



Back unloading



Trailers	2TSP-6	2TSP-8	2TSP-14	2TSP-14 wood chips trailer	2TSP-16	2TSP-21	3TSP-24	4TSP-32
Sides of unloading	3	3	3	1	3	3	3	3
Empty weight, kg	1 500	2 100	3 600	3 900	4 000	5 000	6 000	8 000
Technically permissible total mass, kg	6 000	8 100	13 600	13 900	16 000	21 000	24 000	40 000
Axes, pcs.	2	2	2	2	2	2	3	4
Body: length, mm	4 200	4 050	4 970	5 100	4 430	5 400	7 900	8 550
width, mm	2 245	2 105	2 170 / 2215	2 300	2 270 / 2310	2 270 / 2 310	2 270 / 2 310	2 490
height, mm	600	500	600	2 300	800	800	800	800
The height of the 2nd tier of the sides, mm	600	500	600 (800)	-	800	800	800	800
Volume with 1 tiers of sides, m³	5	4,2	7	24	-	-	-	-
Volume with 2 tiers of sides, m³	10	8,4	14 (16,5)	-	16	21	24	32
Standart wheels	11,5/80-15,3	11,5/80-15,3	500/50-17	425-70 R18	445/45 R19,5	385/65R22,5	385/65R22,5	385/65R22,5
Maximum wheels	15,3	355/65-16	500/50-17	425-70 R18	445/45 R19,5	445/65R22,5	445/65R22,5	445/65R22,5
Recommended tractor power (hp)	30	80	100-110	100-110	120-150	120	from 130	300



Spring drawbar



Board damping spring



Spare wheel



Side unloading



Back unloading



2TSP-14 chip carriers with a body volume of 24 m³



Augers for trailers with side unloading



Augers for trailers with rear unloading



Tow bar for connecting a second trailer



2TSP-14 + 2TSP-14



4TSP-32



2TSP-6



2TSP-8



2TSP-14



2TSP-16



2TSP-21



3TSP-24



SEMI-TRAILER TSP-12 BUILDING

Semi-trailers	TSP-12 building
Technically permissible total mass, kg	26 500
Empty weight, kg	7 200
Dimensions, LxWxH, mm	
- body	6325 x 2530 x 1385
- semi-trailer	7435 x 2530 x 2180
Volume, m ³	11,5
Body metal	Hardox 6 mm
Suspension	tandem / bogie / pendle axle
Tires	650/50 R22,5 650/55 R26,5
Recommended tractor power (hp)	250-300



Telescopic hydraulic cylinder DiNatale (Italy)

SPECIAL TRAILERS

The PS-22 trailer is unloaded to a height of up to 4.0 m. Designed for harvesting corn in cobs, etc. agricultural crops. Thanks to the sliding drawbar, it is aggregated with tractors and combines.

Technical characteristics:

- unloading speed up to 2 min;
- body roll angle 400
- centralized system of lubrication of main nodes

Characteristics	PS-22
Volume, m ³	22
Empty weight, kg	9500 - 9940
Technically permissible total mass, kg	20 440
Trailer: length, mm	8 660 - 9 860
width, mm	3 465
height, mm	3 315
Axles, pcs.	1
Tires	650/65-30.5



Connecting with combine



Axles ADR/BPW



Tandem



Hydraulically opening tailgate

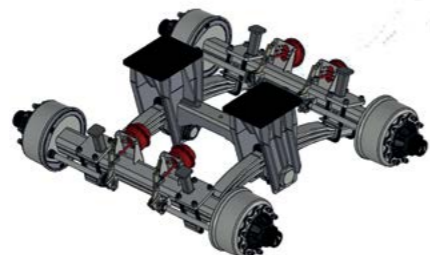

Bogie



Hydraulic drawbar support

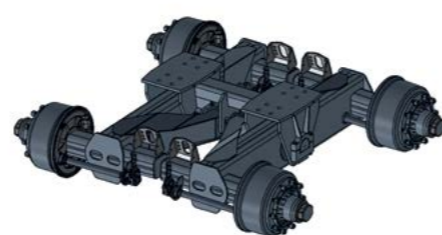

Pendle axle BPW



The maximum unloading height is 4,000 mm



Unloading strips
(for connection with a combine harvester)



Retractable drawbar



DOLLY TRAILERS PSP-20

Dolly trailers PSP-20 are designed for transportation of automobile semi-trailers by tractor on a wet field.

Characteristics	PSP-20
Length, mm	4 900
Width, mm	2 450
Height, mm	1 150
Seat height (adjustable by two hydraulic cylinders), mm	1250 - 1400
Saddle load, kg	20 000
Axles, pcs.	2
Tires	425/65 R22,5

Technical characteristics:

- frame: steel, coated with anti-corrosion paint
- platform: the all-welded metal structure is equipped with a special saddle for transporting an automobile semi-trailer;
- raising / lowering the platform saddle hydraulic;
- drawbar: welded to the frame rigidly;
- connection ring 40 mm, 50 mm, 90 mm;
- electrical system: 12 (24) V has a 7 pole outlet and tail-lights;
- hydraulic cylinders for regulation of coupling height
- the trailer is equipped with a pneumatic braking system.

Additional equipment:

- autonomous hydraulic machine with oil tank, drive from tractor PTO.



PSP20 Dolly



Connection of PSP-20 Dolly with a truck semi-trailer and tractor

ZAVOD KOBZARENKO (UKRAINE)

42500, Sumy region., Lypova Dolyna, Rusanivska street, 17
 Lanovy Sergiy speaks English
 Mob. +38(050) 307-27-17; s.lanovyi@kobzarenko.com.ua
 Choroschaewa Tanja speaks Germany, English
 Mob. +38 (095) 478-25-16; choroschaewa@kobzarenko.com.ua

www.kobzarenko.com.ua

KOBZARENKO SP.Z O.O. (POLAND)

Milenijna 2, 97-410 Żłobnica
 Kobzarenko Iryna speaks English, Polish
 Mob. +48 519 826 528; irina@kobzarenko.eu
 Shovkun Michael speaks English
 Mob. +48 780 089 436; m.shovkun@kobzarenko.eu
 Postol Ihor speaks Polish, English
 Mob. +48 503 776 010; ihor.postol@kobzarenko.eu

www.kobzarenko.eu



youtube.com/c/ZavodKobzarenka



facebook.com/zavodkobzarenka



instagram.com/zavodkobzarenka



tiktok.com/@zavodkobzarenka